

Transportstellung
transport width 3000

Transportbreite 2109
transport width 2109

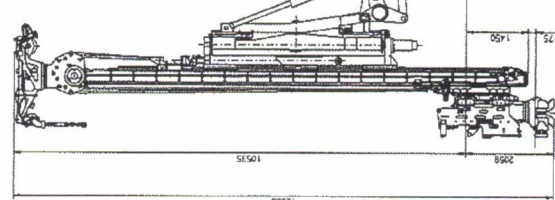

Hydraul. Zylinder I
3m Hub - stroke
leader cylinder I

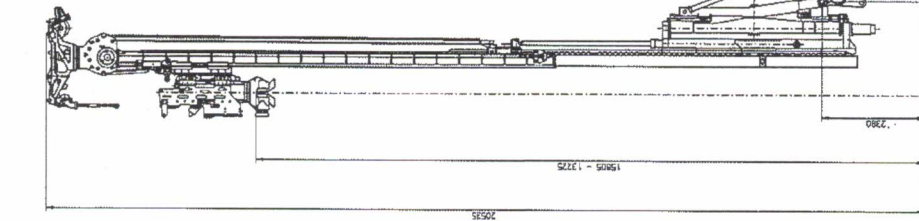
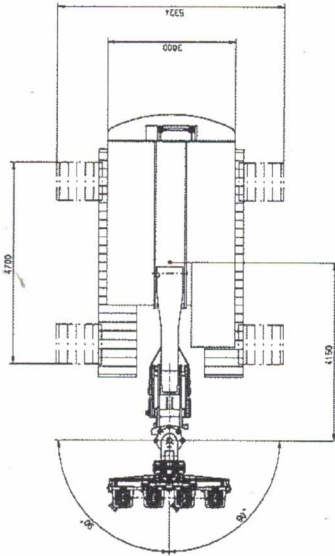
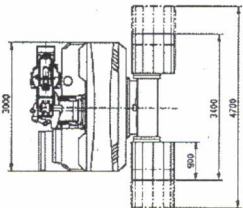
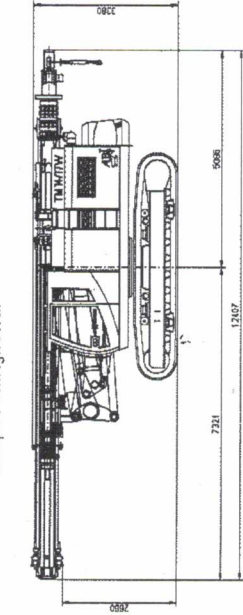
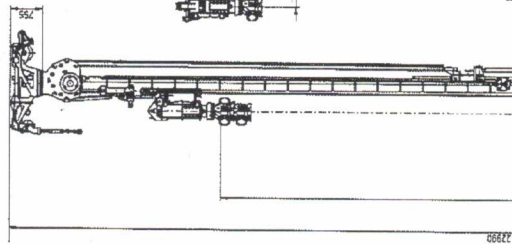

Hydraul. Zylinder II
3m Hub - stroke
leader cylinder II

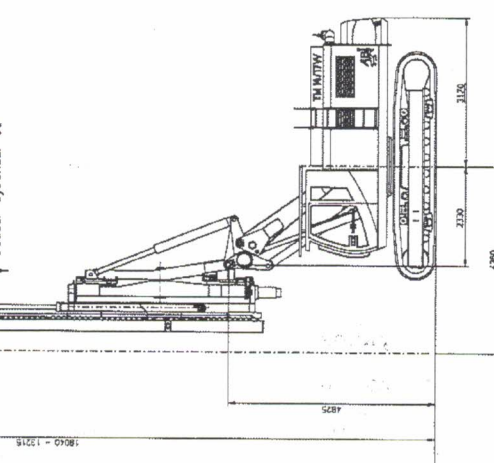

kleinste Reichweite - minimum reach

größte Reichweite - maximum reach

größte Unterflurbabsenkung - maximum lowering depth

Gewicht Trägergerät SR35T T41/380 38500 kg
incl. Gegengewicht
weight of carrier SR35TC T41/380-2
incl. additional counterweight

Anbaugewicht TM 14/17 SB 16600 kg
kpl. mit Grundarm, Grundarmzyl.
und 50kN Hilfswinde (ohne Arbeitsgerät)
weight of ABI part TM 14/17 SB
complete with main boom and cylinders
50kN aux. winch (without attachments)

Gesamtgewicht 55100 kg
total weight

Ramm und Ziehvibrator MRZV 20V
vibrator MRZV 20V
Hydro-Press-System HPZ 500-720
Hydro-Press-System HPZ 500-720

Konzeptzeichnung - Die Angaben in dieser
Zeichnung sind als annähernd zu befrachten.
Änderungen in Konstruktion und Ausstattung
sind vorbehalten.

Concept drawing - The details in this
drawing have to be regarded as approximate.
Design subject to modification.

ABE	
Abteilung	TR 4/7 SB
Abt. Nr.	AB-457
Blatt Nr.	2
Blatt	2